

PROSUPPORT TUBE SYSTEM

ADJUSTABLE AND MODULAR SUPPORTS SYSTEM FOR OUTDOOR FLOATING FLOORS

PROSUPPORT TUBE SYSTEM is an adjustable and modular supports system for outdoor floating floors from the height of 29 mm to 1000 mm. The system is composed of 1 base, 2 screws, 1 flange, 2 heads and several pvc pipes to obtain the requested height. Both heads, according to the screw, can be fix or self-leveling.

PATENTED

PROSUPPORT TUBE SYSTEM KIT HEIGHTS

FULL KIT - Pack. 40 Pcs. - Items not for sale individually. Minimum order one pack.

A: SUPPORT'S HEIGHT WITH SELF-LEVELING INSTALLATION
B: SUPPORT'S HEIGHT WITH FIX SIDE INSTALLATION
T: THICKNESS OF THE SPACER FLAP

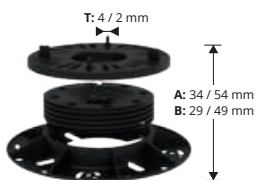

FULL KIT CODE
PST3454/4 T = 4 mm PST3454/2 T = 2 mm
€/Pc. 4,43
€/Pack. 177,20



FULL KIT CODE
PST5474/4 T = 4 mm PST5474/2 T = 2 mm
€/Pc. 4,76
€/Pack. 190,40



FULL KIT CODE
PST7494/4 T = 4 mm PST7494/2 T = 2 mm
€/Pc. 6,71
€/Pack. 268,40



FULL KIT CODE
PST94114/4 T = 4 mm PST94114/2 T = 2 mm
€/Pc. 7,22
€/Pack. 288,80



FULL KIT CODE
PST114134/4 T = 4 mm PST114134/2 T = 2 mm
€/Pc. 7,61
€/Pack. 304,40



FULL KIT CODE
PST134154/4 T = 4 mm PST134154/2 T = 2 mm
€/Pc. 7,98
€/Pack. 319,20



FULL KIT CODE
PST154174/4 T = 4 mm PST154174/2 T = 2 mm
€/Pc. 9,51
€/Pack. 380,40



FULL KIT CODE
PST174194/4 T = 4 mm PST174194/2 T = 2 mm
€/Pc. 9,75
€/Pack. 390,00



FULL KIT CODE
PST194214/4 T = 4 mm PST194214/2 T = 2 mm
€/Pc. 9,95
€/Pack. 398,00

© 2020 All rights reserved by Progress Profiles. Printed in Italy

HEIGHTS GREATER THAN 209 mm

H (mm) SELF-LEVELING HEAD (A)	H (mm) FIX HEAD (B)	Choose the kit according to the desired tile joint (T)		PIPE	FLANGE	€/PC.
214/234	209/229	PST3454/4 T = 4 mm	PST3454/2 T = 2 mm	+ PSTT 175	PSTGH 02	11,18
234/254	229/249			+ PSTT 195		11,85
254/274	249/269			+ PSTT 215		12,26
274/294	269/289			+ PSTT 235		12,76
294/314	289/309			+ PSTT 255		13,36
314/334	309/329			+ PSTT 275		14,07
334/354	329/349			+ PSTT 295		14,07
354/374	349/369			+ PSTT 315		14,97
374/394	369/389			+ PSTT 335		14,97
394/414	389/409			+ PSTT 355		16,14
414/434	409/429			+ PSTT 375		16,14
434/454	429/449			+ PSTT 395		17,68
454/474	449/469			+ PSTT 415		17,68
474/494	469/489			+ PSTT 435		17,68
494/514	489/509			+ PSTT 455		19,86



PST3454/...



PSTGH 02

PRODUCTS FOR LAYING

SELF-LEVELING HEAD MODE

Self-levelling head mode
Max height 1000 mm with max slope of 5%.

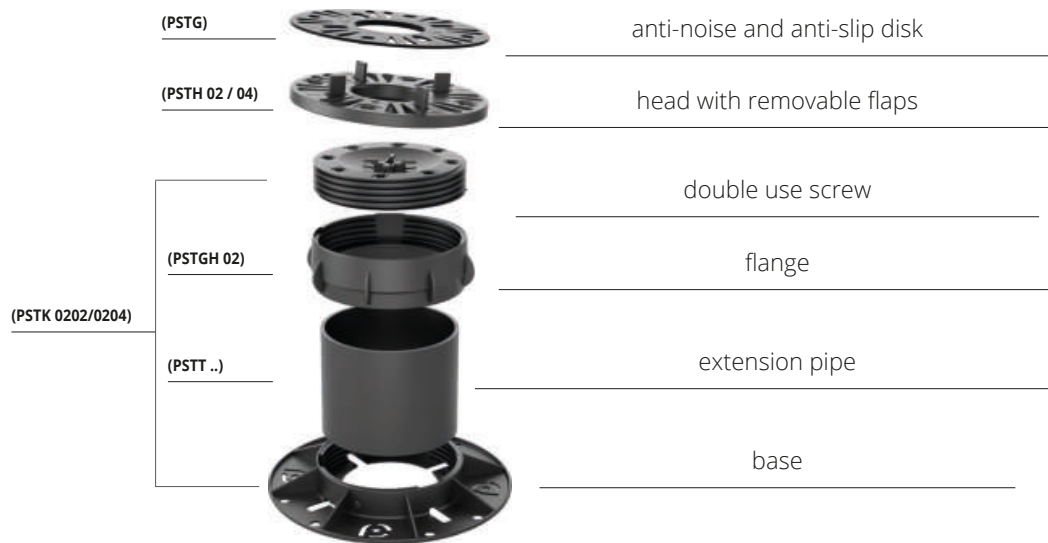

FIXED HEAD MODE

Fixed head mode
Max height 1000 mm

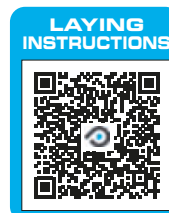

PROSUPPORT TUBE SYSTEM COMPONENTS

BASE + SCREW 20/40 mm
polypropylene - pack. 40 Pcs. (PSTK 0202) - pack. 20 Pcs. (PSTK 0204)

Article	Thickness (mm)	kit / pack.	€/Pc	€/pack.
PSTK 0202	20	40	3,30	132,00
PSTK 0204	40	20	3,61	72,20

Items not for sale individually. Minimum order one pack.

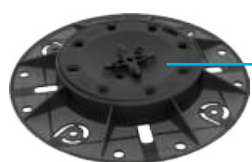

PSTK 0202

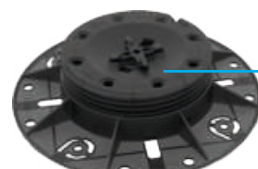

PSTK 0204

HEAD with removable flaps 2/4 mm
polypropylene - pack. 40 Pcs.

Article	flap Thk (mm)	kit/pack.	€/Pc	€/pack.
PSTH 02	2	40	1,13	45,20
PSTH 04	4	40	1,13	45,20

Items not for sale individually. Minimum order one pack.



PSTH 02 / PSTH 04

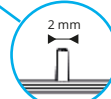

FLAP THICKNESS 2 mm - PSTH 02

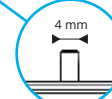

FLAP THICKNESS 4 mm - PSTH 04

FLANGE 40 mm
polypropylene - pack. 40 pcs

Article	H (mm)	Pc/pack.	€/Pc	€/Pack.
PSTGH 02	40	40	1,77	70,80

Connection nut with a lower side of 110 mm inner diameter, where the pipe of different heights should be inserted, and one side with thread where the regulation screws should be inserted.

Items not for sale individually. Minimum order one pack.



PSTGH 02

ANTI-NOISE AND ANTI-SLIP DISK
rubber - H 1,5 mm - Ø 150 - pack. 120 pcs

Article	H / Ø mm	Pc/pack.	€/Pc	€/Pack.
PSTG	H 1,5 - Ø150	120	1,08	129,60

The non-slip rubber disk to be used with the heads of PROSUPPORT TUBE SYSTEM reduces noises till 25 dB.

Items not for sale individually. Minimum order one pack.



PSTG

PRE-CUT EXTENSION PIPE - outer diameter Ø110 mm Thickness 4 mm - polyethylene polypropylene - pack. 40 Pcs.

Article	H (mm)	Pc/pack.	€/Pc	€/pack.
PSTT 35	35	40	0,50	20,00
PSTT 55	55	40	1,02	40,80
PSTT 75	75	40	1,39	55,60
PSTT 95	95	40	1,77	70,80
PSTT 115	115	40	3,30	132,00
PSTT 135	135	40	3,55	142,00
PSTT 155	155	40	3,74	149,60

Items not for sale individually. Minimum order one pack.



PSTT...

FULL LENGHT EXTENSION PIPE - outer diameter Ø110 mm Thickness 4 mm - polyethylene or polypropylene - pallet 43 Pcs.

Article	H (ml)	ml/pallet.	€/ml	€/Pc	€/pallet
PSTT 2700	2,7	116	24,09	65,04	2796,72

Items not for sale individually. Minimum order one pallet.

UPON REQUEST IT IS POSSIBLE TO HAVE HEIGHTS TILL 1000 MM USING PIPES FROM 155 TILL 955. For information and installation instructions ask for the technical data sheet. Price to be agreed. Production delay 4/5 weeks.



PSTT 2700

270 cm

PERIMETER SPACER

Perimeter spacer of stainless steel AISI 316L / 1.4404 - V4A for laying outdoor floating floors. The profile makes a 5 mm wide perimeter gap, for the outflow of rainwater; moreover, thanks to the rounded fin with which is provided, it does not damage the waterproofing sheath. The slit width of 0.5 cm and the length of 18 cm ensure a perfect anchorage of the spacer with the heads of the Prosupport System.

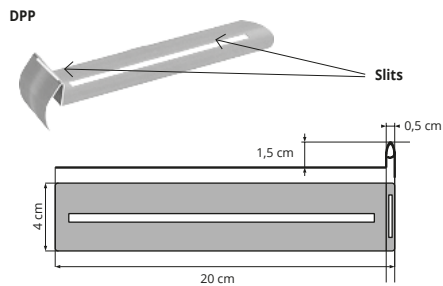

PERIMETER SPACER PROSUPPORT SYSTEM
Stainless steel AISI 316L / 1.4404 - V4A - pack. 40 Pcs



Article	€/Pc	€/Pack.
DPP	3,55	142,00

PROSUPPORT TUBE SYSTEM OPTIONAL

ADJUSTING KEY (only for head PSTH 04)

Article	€/Pc
PSTAK	31,50



ADJUSTABLE SPACER TABS 4 mm
polypropylene - Pack 80 pcs

Article	L x H mm	Pcs/pack	€/Pc	€/Pack.
PSTJ	80 x 20	80	0,83	66,40

Spacer tabs 80 mm long to be fixed on the self-levelling head, which allow the fixing of wooden, WPC and aluminium joists of max width 80 mm.



Items not for sale individually. Minimum order one pack.

FIXING CLIP FOR TILES - WIND-PROOF
Pack 40 pairs

Article	L x H mm	pairs/pack	€/Pair	€/Pack.
PSTWP	20 x 60	40	6,09	243,60

Fastening clip to fix the tiles and block the floor in case of strong wind. The clips must be inserted inside the cross joint or along the perimeter of the floor.



Items not for sale individually. Minimum order one pack.

RUBBER DISK for laying on bituminous roof membrane
H 2 mm - Pack. 100 Pcs (box 100 pcs)

Article	H (mm)	€/Pc	€/Pack.
LVGG 02	2	1,96	196,00

Rubber disc, 2 mm thick, to be applied under the support (SQG 15) to protect the bituminous membrane.



SPACER FOR APPLICATION ON GRAVEL
Pack. 100 Pcs (box 100 pcs)

Article	€/Pc	€/Pack.
DILV	0,91	91,00

Transparent plastic 4 mm cross spacer for laying on gravel or irregular surfaces.



PRODUCTS FOR LAYING

© 2023 All rights reserved by Progress Profiles. Printed in Italy

PROSUPPORT PROFILE T & N is a profile for the protection and finishing of the external edge of raised floors in ceramic, wood and composite materials. The vertical section of the profiles features a specially designed fins that create a dovetail cladding system. This dovetail cladding system allows for the adhesive used to fix the covering to also mechanically bond to the profiles. The profile is also available with a decorative edge of 2 cm height (PROSUPPORT PROFILE T).

PROSUPPORT PROFILE T & N

VARNISHED ALUMINIUM
NATURAL ALUMINIUM

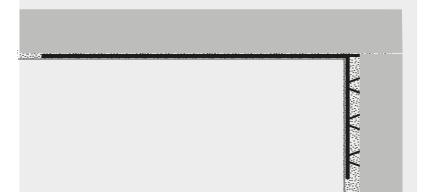
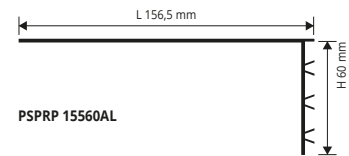
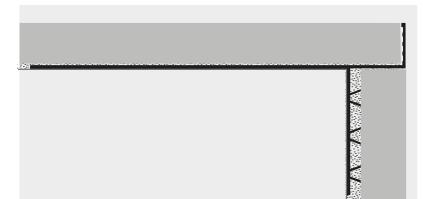
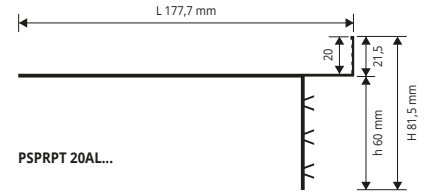

PROSUPPORT PROFILE T - VARNISHED ALUMINIUM

bar length 2,7 lm - pack. 20 Pcs - 54 lm

Article	L x H mm	h mm	€/lm	€/Pc
PSPRPT 20AL...	177,7x81,5	60	31,34	84,62

COLOURS (EMBOSSSED)



PROSUPPORT PROFILE N - NATURAL ALUMINIUM

bar length 2,7 lm - pack. 20 Pcs - 54 lm

Article	H mm	L	€/lm	€/Pc
PSPRP 15560AL	60	156,5	20,89	56,40

COLOURS



* ON DEMAND (EMBOSSSED)

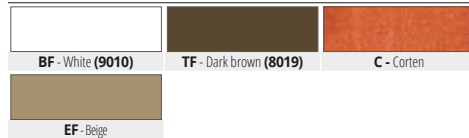

LAYING INSTRUCTIONS

1. Choose "PROSUPPORT PROFILE" desired model. 2. Cut "PROSUPPORT PROFILE" to the desired length and put on the supports and aligning. 3. Lay the floor by adjusting the height of the supports until completely leveling. 4. Cut the tiles of the correct size to close the perimeters of the floating floor. 5. Fix on the vertical surface of the profile the tiles using a suitable adhesive.

PROSUPPORT SYSTEM A&B Perimeter profile to protect and finish the outer edge of raised floors of different types, ceramic, wood, stone etc. The **PROSUPPORT PROFILE A** consists in an "L"-shaped horizontal flat base to insert and anchor above the **PROSUPPORT** Self-levelling head and a vertical visible part to insert in the vertical "L"-shaped element (as indicated in the drawing).

Use: Perimeter profile to protect and finish the outer edge of raised floors of different types, ceramic, wood, marble etc. The **PROSUPPORT PROFILE** consists in an "L"-shaped horizontal flat base to insert and anchor above the **PROSUPPORT** Self-levelling head and a vertical visible part to insert in the vertical "L"-shaped element (as indicated in the drawing)

PROSUPPORT PROFILE A & B

VARNISHED ALUMINIUM,
NATURAL ALUMINIUM

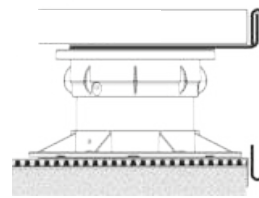

PUNCHED AND PERFORATED PROSUPPORT A

NATURAL ALUMINIUM - length 2,7 lm - pack. 20 Pcs

Article	L x H	€/lm	€/Pc
BPPSAN 15015	150 X 15	27,36	73,87
BPPSAN 15020	150 X 20	28,67	77,41
BPPSAN 15025	150 X 25	29,98	80,95

COLOURS



TOP PROFILE PROSUPPORT B - VARNISHED ALUMINIUM

length 2,7 lm Pack 10 Pcs (PFPSAL...1060 Pack 20 Pcs)

Article	H1	€/lm	€/Pc
PFPSAL... 1060	60	20,25	54,68
PFPSAL... 1080	80	23,51	63,48
PFPSAL... 10100	100	26,45	71,42

COLOURS (EMBOSSSED)



* ON DEMAND (EMBOSSSED)

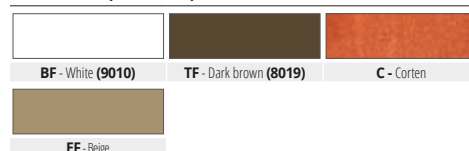

PROSUPPORT A

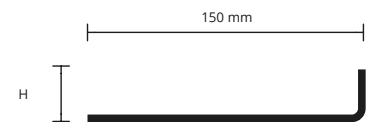

PROSUPPORT B

PFPSAL... 1060 PFPSAL... 1080 PFPSAL... 10100

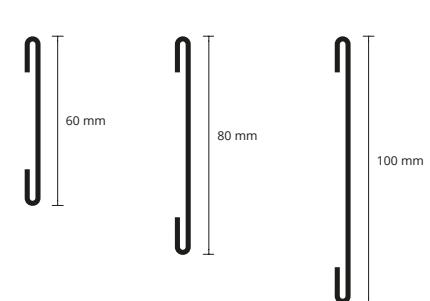

* = Production on demand with minimum quantity of 100 pcs. Production delay 4/5 weeks. Price to be agreed

Prices are referred to whole packs.

PRORAIL SYSTEM

PRORAIL SYSTEM SYSTEM is a modular system composed of aluminium joists to lay floating floors of any size, to create steady and modular substructures together with PROSUPPORT TUBE and PROSUPPORT SLIM. The system consists of two aluminium joists, PRORAIL and PRORAIL RET, one fastening ring PRORAIL RING, two cross spacers with removable flaps PRORAIL SPACER and one anti-noise and anti-slip rubber PRORAIL RUBBER

PRORAIL
PSTRAN 53

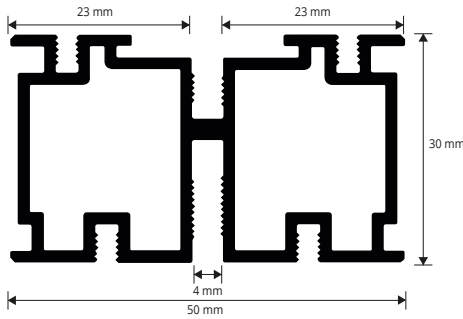

PRORAIL - SHAPED JOIST
aluminium - Pack 10 Pcs - Bar length 2,7 Lm

Article	L x H (mm)	Pc/Pack	€/lm	€/Pc
PSTRAN 53	50 X 30	10	16,48	44,50



PRORAIL RUBBER
Roll length 110 Lm

Article	L roll ml	€/lm	€/roll
PSTR1	110	1,90	209,00

PRORAIL RET
PSTRAN 5030

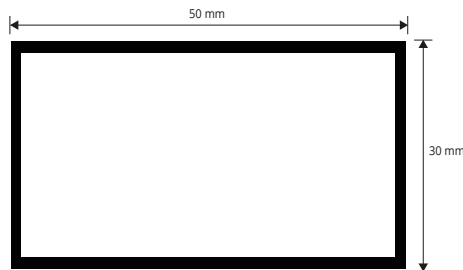

PRORAIL RET - SMOOTH JOIST
aluminium - Pack 10 Pcs - Bar length 2,7 ML

Article	L x H (mm)	Pc/Pack	€/lm	€/Pc
PSTRAN 5030	50 X 30	10	11,41	30,81



PRORAIL RING - JOIST FASTENING RING
polypropylene - Pack 40 Pcs

Article	Ø mm	Pc/Pack	€/Pc	€/Pack
PSTRR	135	40	0,88	35,20

PRORAIL SYSTEM LAYING PATTERN

- Material required for 1 qm of the below pattern:
- 3 pcs **PROSUPPORT TUBE/PROSUPPORT TUBE SLIM**
 - 3 pcs fastening rings **PRORAIL RING**
 - 2.7 lm **PRORAIL** joist
 - 4 lm **PRORAIL RUBBER**

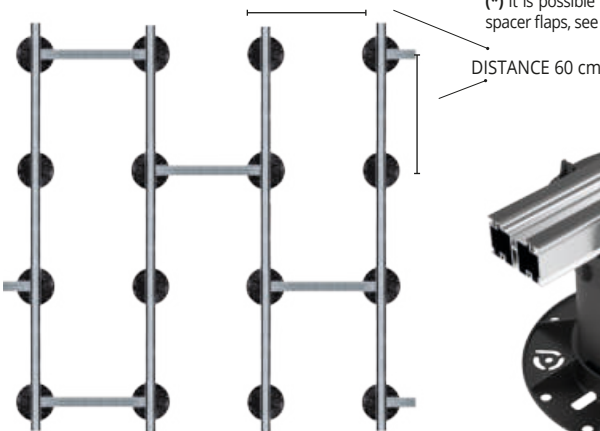

TECHINICAL LAYING INSTRUCTIONS

1. Choose the support **PROSUPPORT TUBE** or **PROSUPPORT SLIM** of the required height;
2. Set the fastening ring **PRORAIL RING** on the supports;
3. Set the joist **PRORAIL (*)** or the joist **PRORAIL RET** on the ring;
4. Insert the rubber **PRORAIL RUBBER** inside the grooves of the joist **PRORAIL**;
5. Set the cross spacers **PRORAIL SPACER** following the laying pattern; (*) It is possible to fix the joist **PRORAIL** on the supports fixing it into the spacer flaps, see picture hereunder.



PRORAIL SPACER
PSTRS 02



PRORAIL SPACER
PSTRS 04

PRORAIL SPACER - CROSS SPACER with removable flaps
polypropylene - Pack 100 Pcs

Article	thickness (mm)	Pc/Pack	€/Pc	€/Pack
PSTRS 02	2	100	0,76	76,00
PSTRS 04	4	100	0,88	88,00

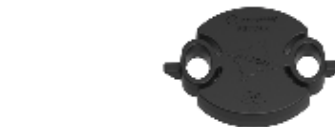
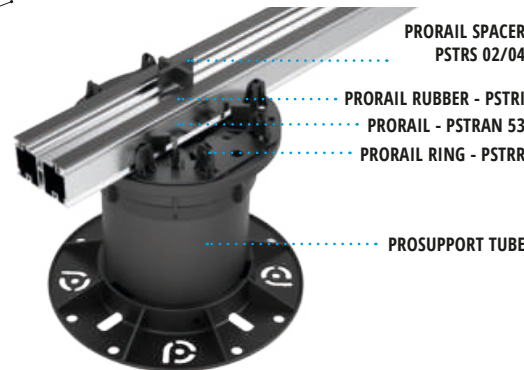

ANTI-ROTATION CLIP - Pack 40 Pcs

Article	Pc/Pack	€/Pc	€/Pack
PSTCAR	40	1,05	42,00

FIXING WITH PRORAIL JOIST:

Prosupport tube/slim + Prorail + Prorail spacer + Prorail rubber

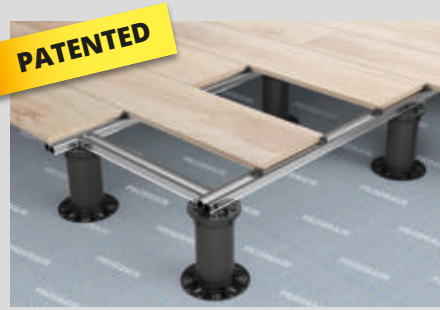

FIXING WITH RING AND PRORAIL JOIST:

Prosupport tube/slim + Prorail ring + Prorail + Prorail spacer + Prorail rubber



FIXING WITH RING AND PRORAIL RET SMOOTH JOIST :

Prosupport tube/slim + Prorail ring + Prorail ret



© 2023 All rights reserved by Progress Profiles, Printed in Italy

PRODUCTS FOR LAYING

PATENTED

© 2023 All rights reserved by Progress Profiles. Printed in Italy



PROSUPPORT
TUBE

PRORAIL RING

PRORAIL

PRODRAIN 10
(OPTIONAL)

PRORAIL
RUBBER

PRORAIL
SPACER

PRODUCTS
FOR LAYING